

Ficha Técnica

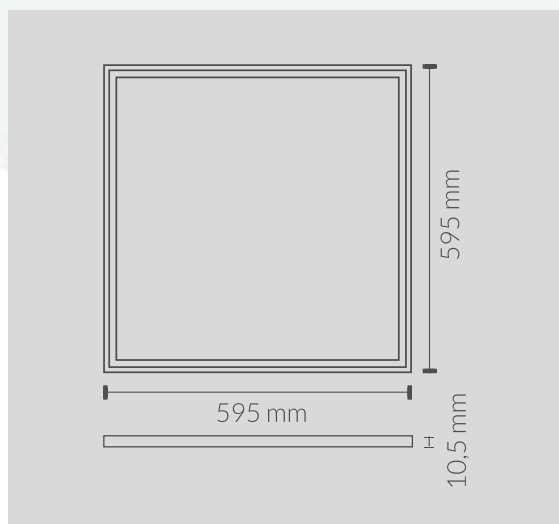

CODIGO	POTENCIA	LM	TENSION
606040CWRK	40w	3900lm	100-250v

ESPECIFICACIONES TÉCNICAS

Ángulo de Apertura	120°
UGR	<22
IK	06
Temperatura de Color	6000k
IRC	>80
LED Chip	SMD2835
Temperatura de Trabajo	-20°/50°
Material	Aluminio
Acabado	Blanco
Dimensiones	595x595mm
Certificados	CE&Rohs



ESPECIFICACIONES LUZ DE EMERGENCIA

Potencia	4w
Luminosidad	390lm
Autonomía	90min
Función	No Permanente
Batería	Ni-Cd 3.7v/2500Ah